

Article number: 12748000060110

Description: KLEE-coil 748 000 060.110
M6 Steel, zinc-pl. & chr. blue

Measures

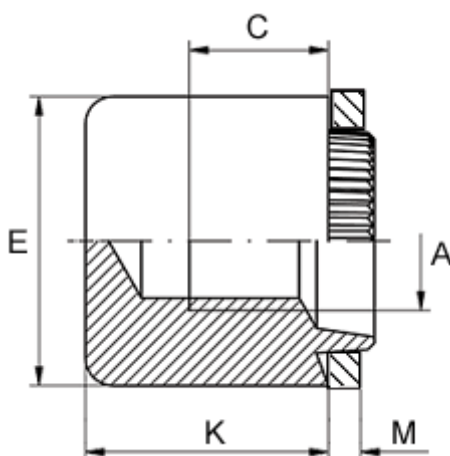

Female thread A	= M6
Height K	= 11.0
Min thread length C	= 6.0
Outer diameter E	= 13.0
Plate thickness	= 2.0 to 2.2
Recommended bore diameter for extreme load	= 10.0
Recommended bore diameter for normal use	= 10.0